





20 705 819



- 165mm projection
 - 1 1/4" pop-up waste
 - pivotable spout 360°
 - circular, air-enriched flow
 - height of mixer 144 mm
 - height up to aerator 90 mm
 - hole diameter valve 32 mm
 - hole diameter spout 35 mm
 - rosette Ø 60 mm
 - max. flow 4.5 l/min
 - lead-free
 - This product can help a building meet the requirements of Green Building Rating Systems, e.g. LEED®, BREEAM®, DGNB
- Only suitable for basins with an overflow.

	Chrome	20 705 819-00 0010
	Brushed Platinum	20 705 819-06 0010
	Platinum	20 705 819-08 0010
	Brushed Durabronze (23kt Gold)	20 705 819-28 0010
	Brushed Bronze	20 705 819-42 0010
	Brushed Champagne (22kt Gold)	20 705 819-46 0010
	Champagne (22kt Gold)	20 705 819-47 0010
	Brushed Dark Platinum	20 705 819-99 0010

20 705 819

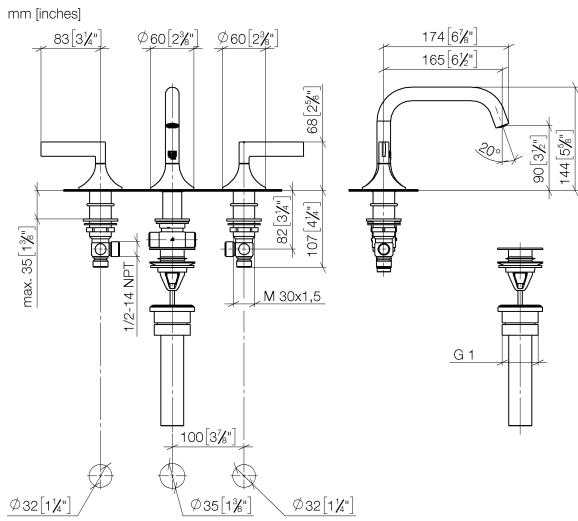

Flow rate chart

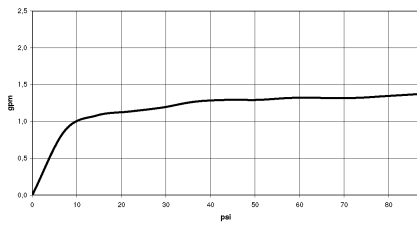

Codes & Standards

California Energy
Commission
(CEC)

20 705 819

Parts for other finishes can be found here: [Brushed](#) [Platinum](#)

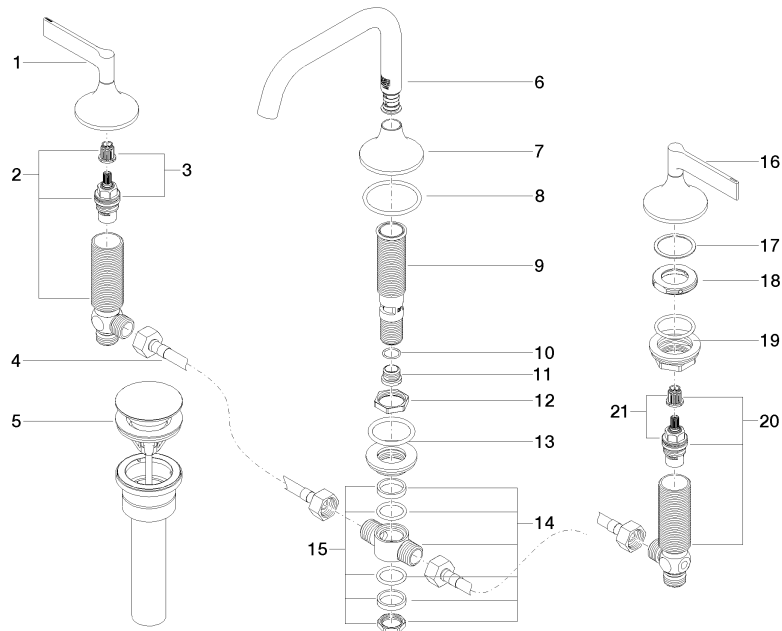

Spare parts list

No.	Item Number	Name	Quantity used	Delivery time
1	90 20 80 013 00-00	handle (hot)	1	10
2	04 17 11 055 51 90	side panel	1	2
3	90 90 03 151 00 90	top	1	2
4	04 30 04 096 00 90	hose	2	2
5	10 125 970-00 0010	Basin Waste 1 1/4" - Chrome	1	2
6	90 28 22 369 00-00	spout	1	10
7	09 27 80 011-00	rosette	1	10
8	09 14 10 084 90	seal	2	2
10	09 14 10 017 90	seal	1	2
11	09 24 04 021 10 90	nipple	1	2
12	09 23 10 127 90	nut	1	2
13	04 23 10 004 04 90	fixing set	1	2
14	90 17 11 020 10 90	distributor	1	2
15	90 23 10 012 00 90	gasket kit	1	2
16	90 20 80 012 00-00	handle (cold)	1	10
17	09 28 10 003 90	ring	2	2
18	09 24 01 028 90	ring	2	2
19	04 23 10 032 78 90	fixing set	2	2
20	04 17 11 055 50 90	side panel	1	2
21	90 90 03 150 00 90	top	1	2